

10.6 Practice A

In Exercises 1–12, find the value of x .

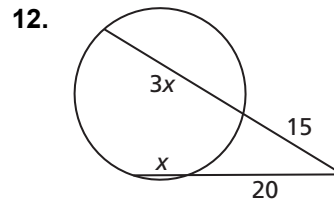

13. The Xs show the positions of two basketball teammates relative to the circular “key” on a basketball court. The player outside the key passes the ball to the player on the key. What is the length of the pass?

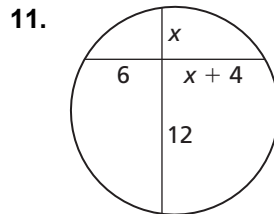
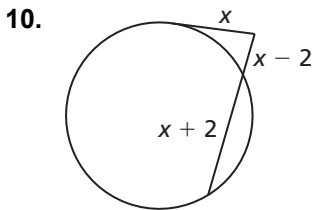
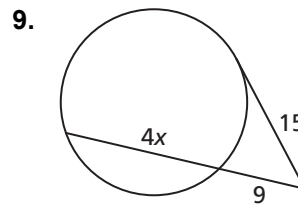
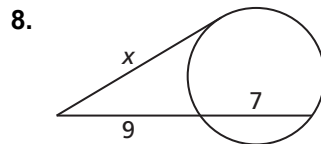
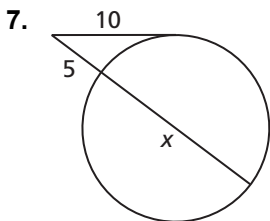
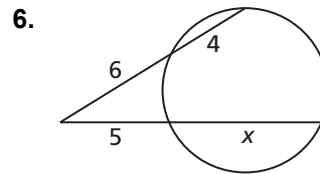
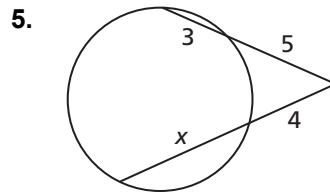
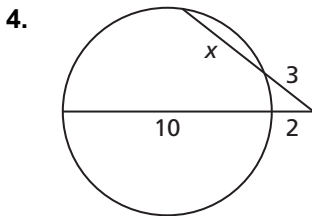
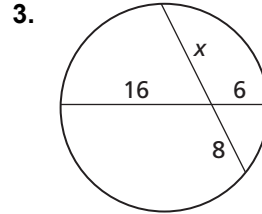
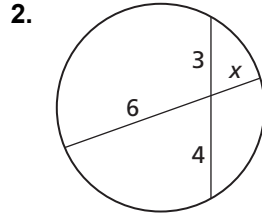
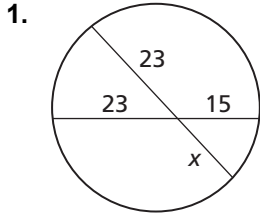
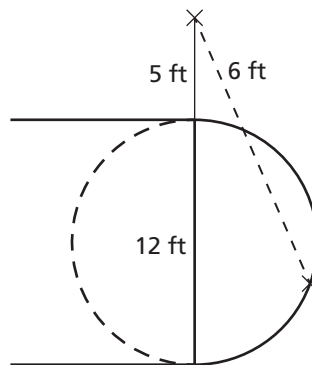

10.6

Practice B

In Exercises 1–9, find the value of x .

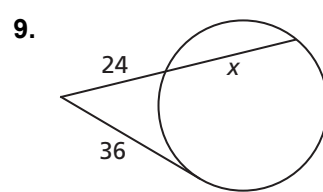
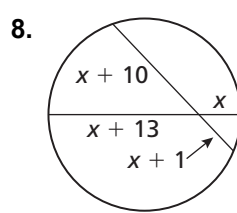
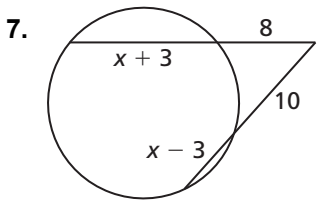
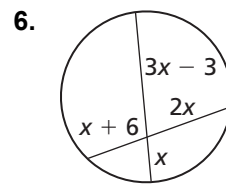
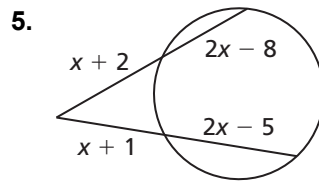
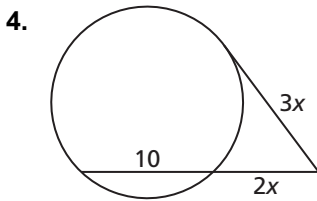
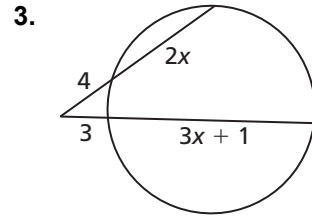
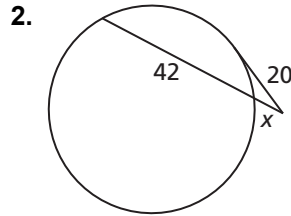
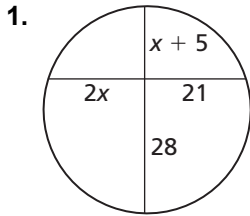

10. A large industrial winch is shown. There are 15 inches of cable hanging free off of the spool and the distance from the end of the cable to the spool is 8 inches. What is the diameter of the spool?

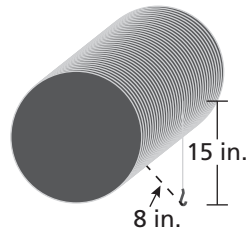

11. The diagram shows a cross-section of a large storm drain pipe with a small amount of standing water. The distance across the surface of the water is 48 inches and the water is 4.25 inches deep at its deepest point. What is the diameter of the storm drain pipe?

